



THE INNOVATIVE PREFABRICATED
FORMWORK FOR CONCRETE STAIRS

[Inquiry form](#)

Stair forms (please check the desired form and direction)

straight



½ turn winding

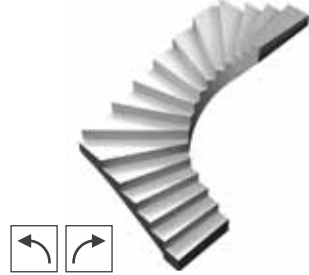

½ turn winding with landing

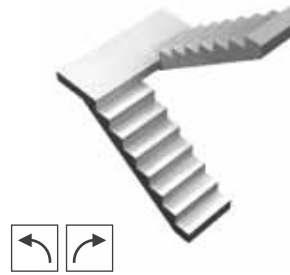

¼ turn

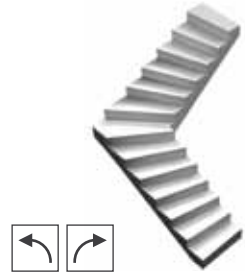

¼ turn winding in entrance

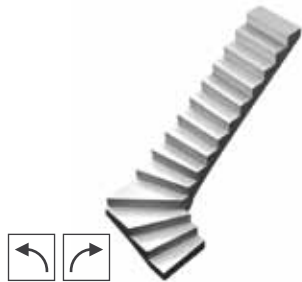

¼ turn winding in exit

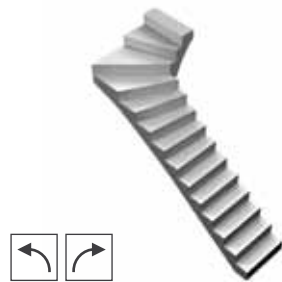

spiral stair wide

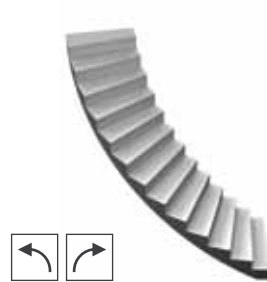

spiral stair narrow



Starting and ending step (please check the desired version)

with ending step

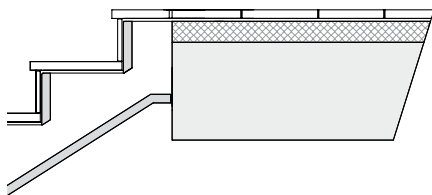

ending step overlying

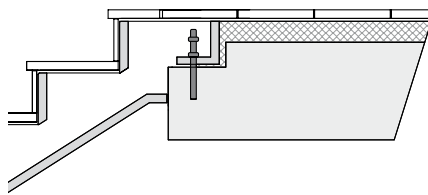

without ending step

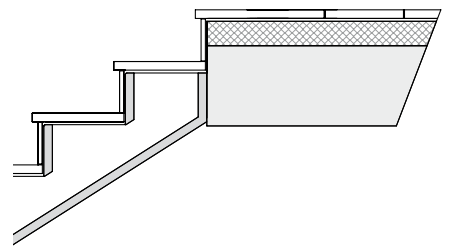

even starting step

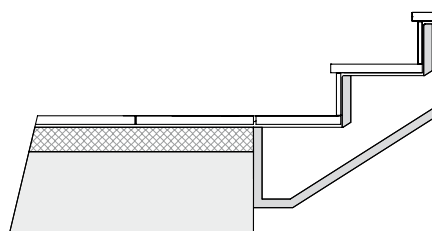

raised starting step

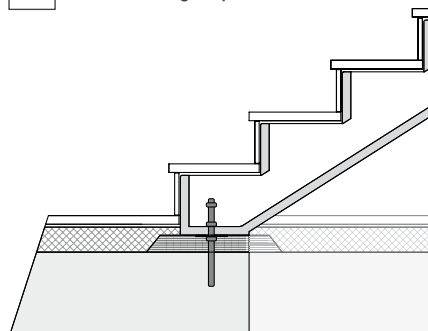

starting step overlying

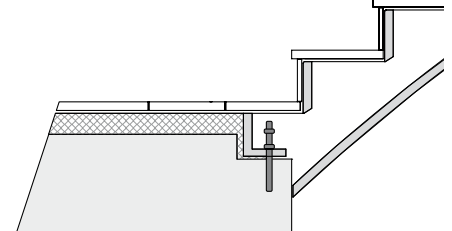

Measures (please fill in precisely in mm)

<table border="1" style="width: 100%; border-collapse: collapse;"> <tr><td style="padding: 2px;">f)</td><td style="padding: 2px;">mm</td></tr> <tr><td style="padding: 2px;">e)</td><td style="padding: 2px;">mm</td></tr> </table> <table border="1" style="width: 100%; border-collapse: collapse;"> <tr><td style="padding: 2px;">f)</td><td style="padding: 2px;">mm</td></tr> <tr><td style="padding: 2px;">e)</td><td style="padding: 2px;">mm</td></tr> <tr><td style="padding: 2px;">d)</td><td style="padding: 2px;">mm</td></tr> </table> <table border="1" style="width: 100%; border-collapse: collapse;"> <tr><td style="padding: 2px;">f)</td><td style="padding: 2px;">mm</td></tr> <tr><td style="padding: 2px;">e)</td><td style="padding: 2px;">mm</td></tr> <tr><td style="padding: 2px;">d)</td><td style="padding: 2px;">mm</td></tr> </table> <table border="1" style="width: 100%; border-collapse: collapse;"> <tr><td style="padding: 2px;">f)</td><td style="padding: 2px;">mm</td></tr> <tr><td style="padding: 2px;">e)</td><td style="padding: 2px;">mm</td></tr> <tr><td style="padding: 2px;">d)</td><td style="padding: 2px;">mm</td></tr> </table>	f)	mm	e)	mm	f)	mm	e)	mm	d)	mm	f)	mm	e)	mm	d)	mm	f)	mm	e)	mm	d)	mm	<p style="text-align: center;">Attic floor</p> <p style="text-align: center;">Upper floor</p> <p style="text-align: center;">Ground floor</p> <p style="text-align: center;">Basement</p>	<table border="1" style="width: 100%; border-collapse: collapse;"> <tr><td style="padding: 2px;">c)</td><td style="padding: 2px;">mm</td></tr> <tr><td style="padding: 2px;">b)</td><td style="padding: 2px;">mm</td></tr> <tr><td style="padding: 2px;">a)</td><td style="padding: 2px;">mm</td></tr> </table> <table border="1" style="width: 100%; border-collapse: collapse;"> <tr><td style="padding: 2px;">c)</td><td style="padding: 2px;">mm</td></tr> <tr><td style="padding: 2px;">b)</td><td style="padding: 2px;">mm</td></tr> <tr><td style="padding: 2px;">a)</td><td style="padding: 2px;">mm</td></tr> </table> <table border="1" style="width: 100%; border-collapse: collapse;"> <tr><td style="padding: 2px;">c)</td><td style="padding: 2px;">mm</td></tr> <tr><td style="padding: 2px;">b)</td><td style="padding: 2px;">mm</td></tr> <tr><td style="padding: 2px;">a)</td><td style="padding: 2px;">mm</td></tr> </table> <table border="1" style="width: 100%; border-collapse: collapse;"> <tr><td style="padding: 2px;">c)</td><td style="padding: 2px;">mm</td></tr> <tr><td style="padding: 2px;">b)</td><td style="padding: 2px;">mm</td></tr> <tr><td style="padding: 2px;">a)</td><td style="padding: 2px;">mm</td></tr> </table>	c)	mm	b)	mm	a)	mm	c)	mm	b)	mm	a)	mm	c)	mm	b)	mm	a)	mm	c)	mm	b)	mm	a)	mm
f)	mm																																															
e)	mm																																															
f)	mm																																															
e)	mm																																															
d)	mm																																															
f)	mm																																															
e)	mm																																															
d)	mm																																															
f)	mm																																															
e)	mm																																															
d)	mm																																															
c)	mm																																															
b)	mm																																															
a)	mm																																															
c)	mm																																															
b)	mm																																															
a)	mm																																															
c)	mm																																															
b)	mm																																															
a)	mm																																															
c)	mm																																															
b)	mm																																															
a)	mm																																															

Measures tread and riser (please fill in precisely in mm)

Wood

Stone

Tiles

Others _____

a)	mm
b)	mm

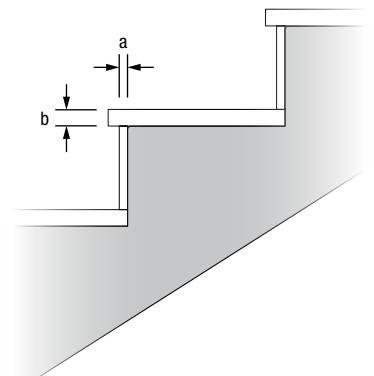

Plan of stairs with ceiling opening (please fill in precisely in mm)



Contact

Title _____

Last name _____

Name _____

Company _____

Address _____

Postcode, city _____

Country _____

Tel. _____ Fax _____

E-Mail _____ Web _____

Please send the filled form (internal pages + last page) to:

FAX: +39 0471 620 676

or

E-Mail: info@scawo.com

Your personal data received is necessary to accomplish all requested services and treated in conformity with italian DPA law no. 196/2003



Metallconcept GmbH

39058 Sarnthein/Sarentino (BZ) - Handwerkerzone 31 Zona Artigianale - Südtirol / Alto Adige Italy
Tel. +39 0471 623 665 - Fax +39 0471 620 676 - info@scawo.com - www.scawo.com